

INTEROBIZ

www.interobiz.ro



Construction

Submersible motor pumps for deep wells of 4" (DN 100 mm), and 6" (DN 150 mm), with external jacket in stainless steel AISI 304 and stages in polycarbonate for 4" pumps and in noryl for 6" pumps.

Impellers

radial impellers	4SD 31,41,45,5,75 - 6SDN 12,16,21
mixed flow impellers	4SD 8,10,15 - 6SD 18,19,20

Connection: screwed connection ISO 228.

Delivery casing with built-in non-return valve.

Applications

For water supply.
For civil and industrial applications.
For fire fighting applications.
For irrigation.

Operating conditions

Liquid temperature: - up to a 25 °C for 4" motors
- up to a 30 °C for 6-8-10" motors.
Max. sand quantity into the water: 100 g/m³.
Continuous duty.

Rewindable motor CS series

2-pole induction motor, 50 Hz (n = 2900 rpm).
Sized for connection to the pumps according to NEMA Standards.
Standard voltages:
- single-phase 230 V up to 2,2 kW for 4" motors.
- three-phase 230 V; 400 V, for 4" motors.
- three-phase 400 V; 400/690 V, for 6" motors.
Voltage tolerance : +6% / -10%.
Recommended type of starting for powers from 7.5 kW:
star/delta, soft start, impedance starting, autotransformer.

Motor	4"	6"
Max. Liquid temperature	30°C	25°C
Max. starts per hour	20	15
Cooling : minimum flow velocity	8 cm/s	16 cm/s

Insulation class F for 4" motors, PVC coated wire for 6" motors.
Protection IP 68.

Cable

Motor 230V - 50Hz - 1~	Section	Length
4CS 0,37 ÷ 2,2 kW	4 G 2 mm ²	2 m
Motor 400V - 50Hz - 3~	Section	Length
4CS 0,37 ÷ 2,2 kW	4 G 2 mm ²	2 m
4CS 3 ÷ 5,5 kW	4 G 2 mm ²	3,5 m
6CS 4 ÷ 22 kW	3 + 1 x 4 mm ²	3,5 m
6CS 26 - 30 kW	3 + 1 x 6 mm ²	3,5 m

Special features on request

- Other voltages.
- 60 Hz frequency.
- Other temperatures.
- Motor FK series.

Designation

Ø of the well in inches _____ 4 SD M 31 / 26
Series _____
Single-phase motor (up to max. 2,2 kW) _____
Stage identification _____
Number of stages _____

Materials

Components	Part Nr.	4SD	6SD - 6 SDN
External jacket	14.02	Cr-Ni steel AISI 304	
Stage casing	25.02	Polycarbonate (Lexan 144 R)	PPO - GF 20 (Noryl)
Diffuser	26.00		
Impeller	28.00		
Wear ring		Cr-Ni steel AISI 304	
Shaft	64.00	Cr steel AISI 430 F	
Delivery casing	12.01	Bronze G-Cu Sn 10 EN 1982	
Suction lantern	32.02	Brass P-Cu Zn 40 Pb 2 UNI 5705	Bronze G-Cu Sn 10 EN 1982
Bearing bush	12.03-12.30	Thermoplastic	Rubber
Strainer	15.50	Cr-Ni steel AISI 304	
Screws		Cr-Ni steel AISI 304	

Components	4CS	6CS
External frame	Cr-Ni steel AISI 304	
Shaft	Cr-Ni-Mo steel AISI 316 (shaft end)	Cr steel AISI 420 Hardened and tempered
Thrust bearing	Oil wetted ball type	Oscillation pads
Bearing bush	Oil wetted ball type	Graphite



Submersible motor pumps for deep wells of 4" and 6"

Coverage chart $n \approx 2900$ rpm

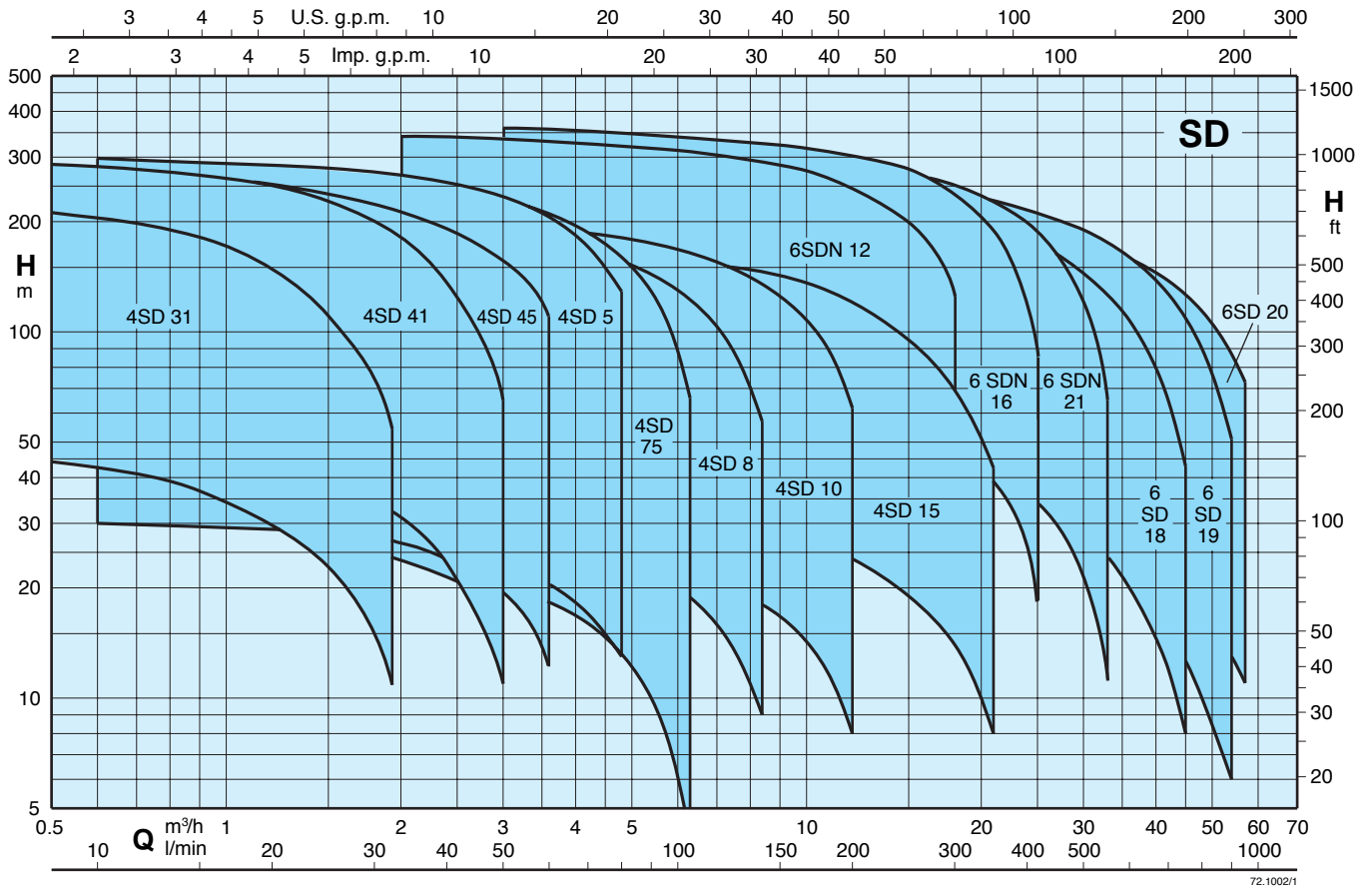

72.1002/1

Characteristic curves $n \approx 2900$ rpm

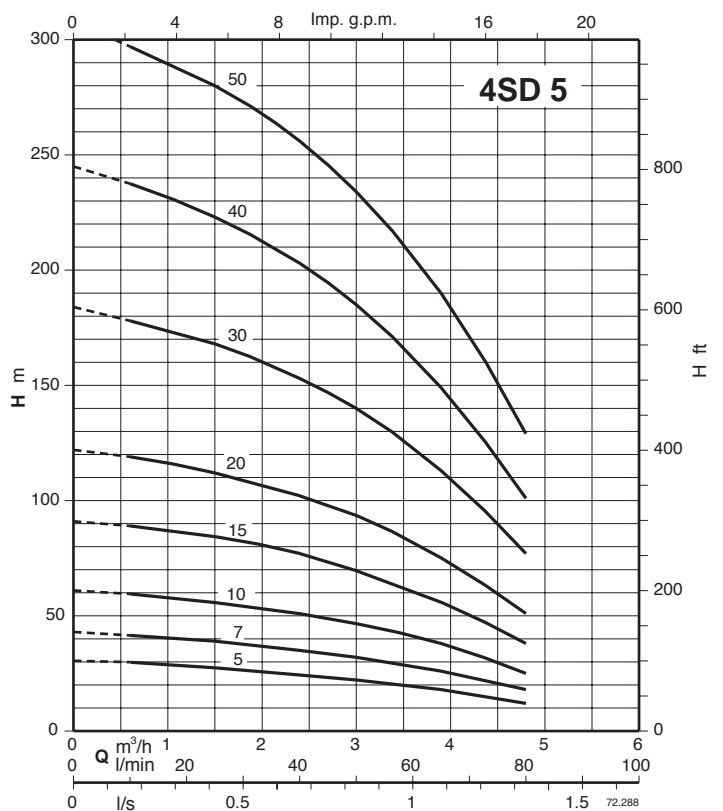
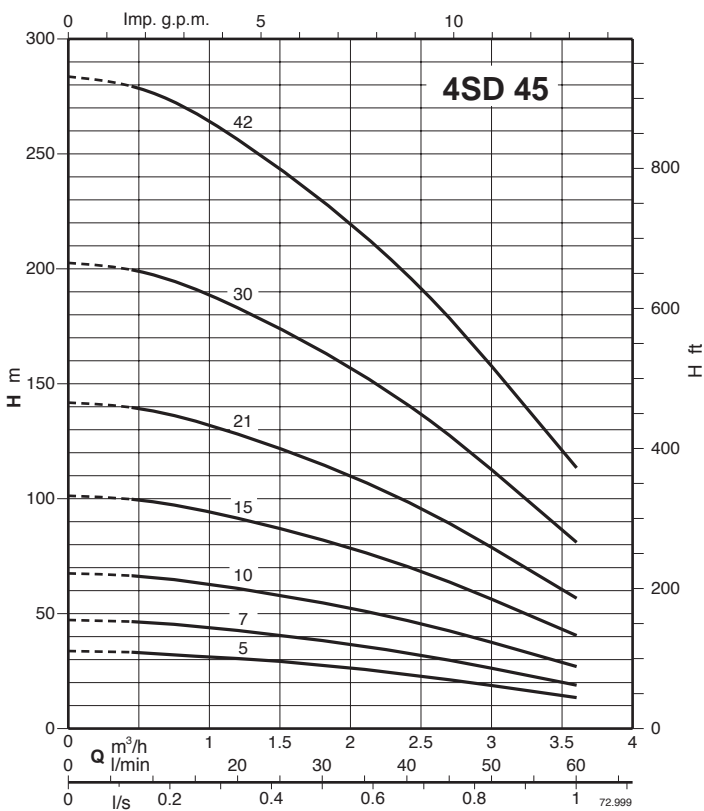
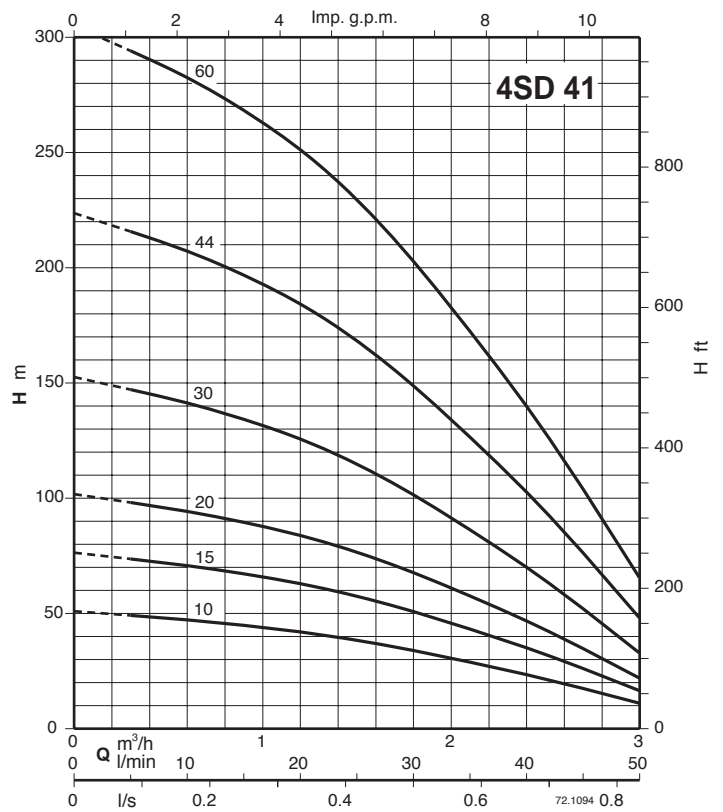
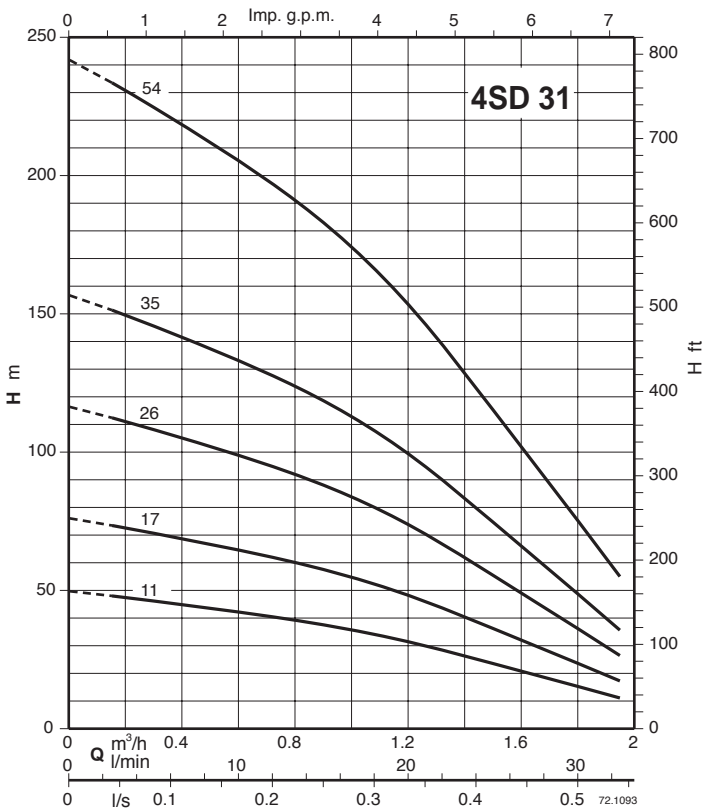

Characteristic curves $n \approx 2900$ rpm

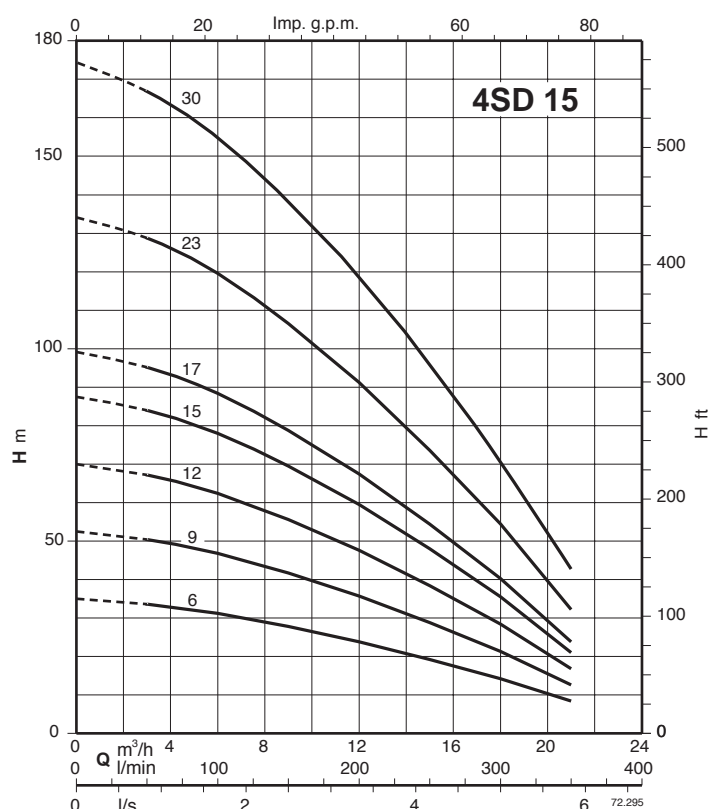
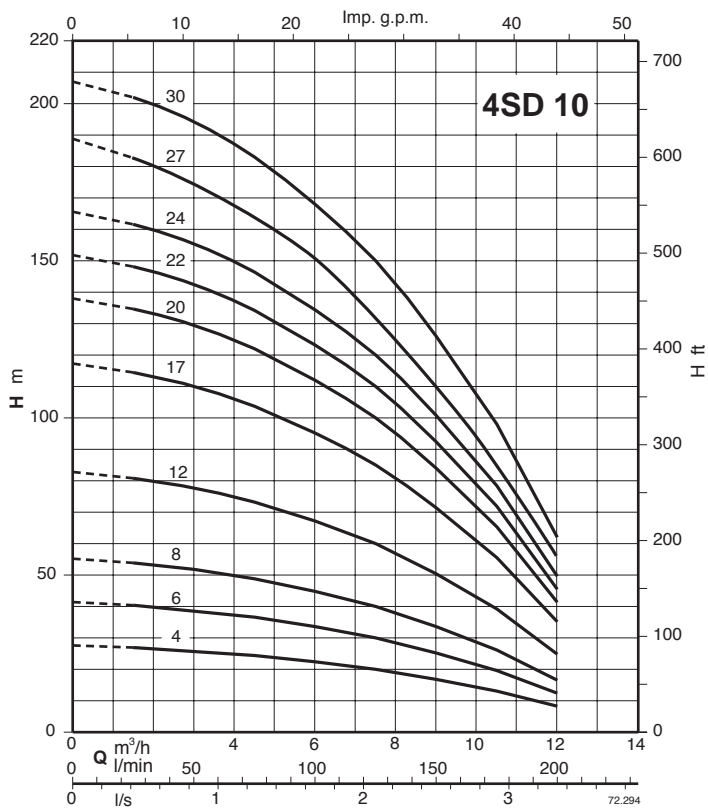
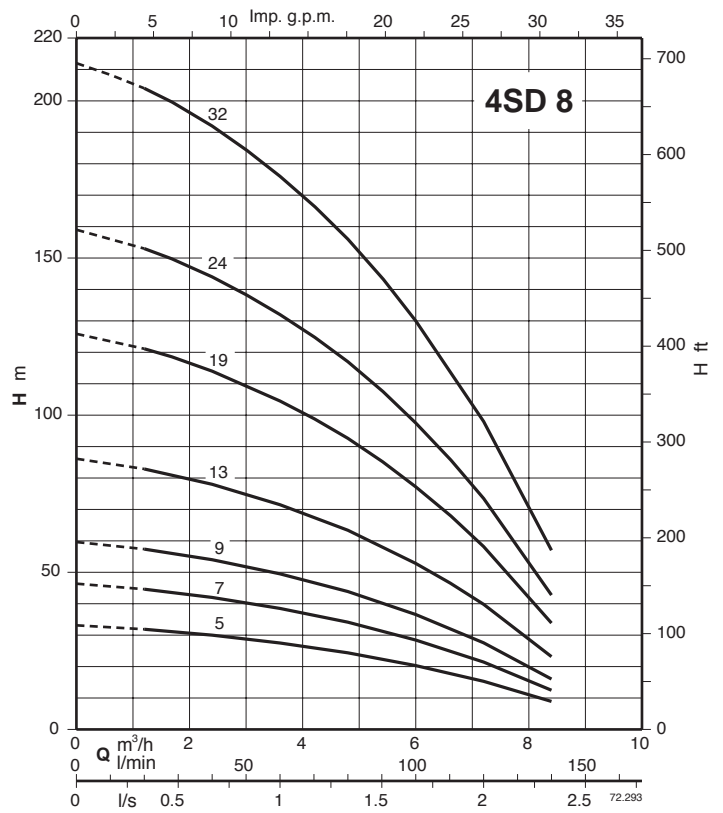
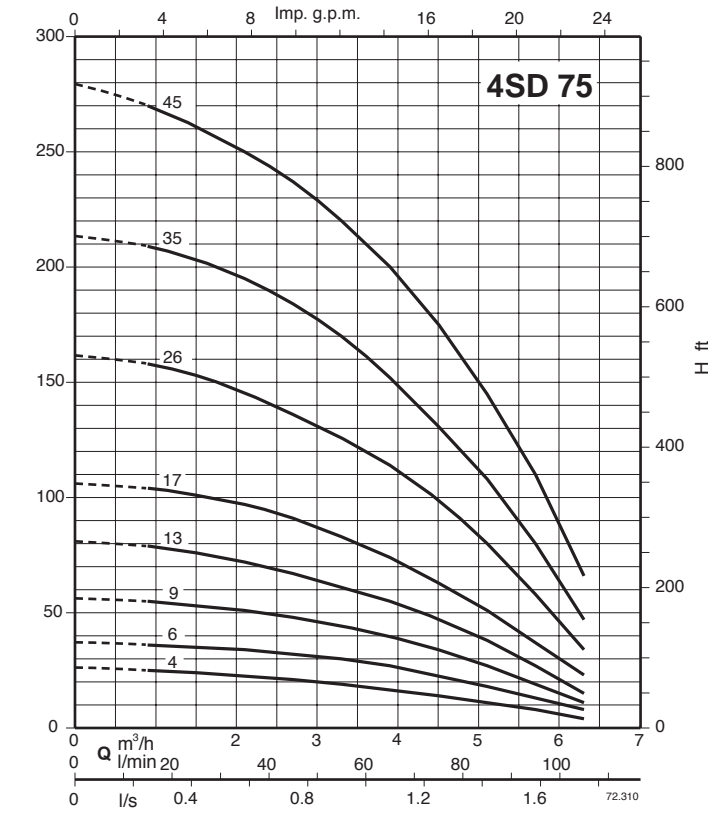

Dimensions and weights

3~	P ₂ kW	DN ISO 228	L mm	L ₁ mm	kg
4SD 31/11EC	0,37	G 1 1/4	712	402	11,5
4SD 31/17EC	0,37		830	520	12,5
4SD 31/26EC	0,55		1008	698	14
4SD 31/35EC	0,75		1205	875	16,5
4SD 31/54EC	1,1		1655	1295	20,8
4SD 41/10EC	0,37	G 1 1/4	693	383	11,3
4SD 41/15EC	0,55		791	481	12,2
4SD 41/20EC	0,75		910	580	16,9
4SD 41/30EC	1,1		1137	777	16,7
4SD 41/44EC	1,5		1442	1052	20,5
4SD 41/60EC	2,2	1858	1368	26,9	
4SD 45/5EC	0,37	G 1 1/4	638	328	10,9
4SD 45/7EC	0,55		693	383	11,6
4SD 45/10EC	0,75		797	467	13,3
4SD 45/15EC	1,1		967	607	15,6
4SD 45/21EC	1,5		1164	774	18,4
4SD 45/30EC	2,2	1515	1025	24,7	
4SD 45/42EC	3	1982	1407	32	
4SD 5/5EC	0,37	G 1 1/4	638	328	10,9
4SD 5/7EC	0,55		693	383	11,5
4SD 5/10EC	0,75		797	467	13,2
4SD 5/15EC	1,1		967	607	15,5
4SD 5/20EC	1,5		1164	746	18
4SD 5/30EC	2,2	1515	1025	24,6	
4SD 5/40EC	3	1879	1304	31,6	
4SD 5/50EC	4	2295	1630	40,6	
4SD 75/4EC	0,37	G 1 1/4	610	300	10,7
4SD 75/6EC	0,55		666	356	11,3
4SD 75/9EC	0,75		769	439	13
4SD 75/13EC	1,1		911	551	15
4SD 75/17EC	1,5		1052	662	16,5
4SD 75/26EC	2,2	1404	914	23,6	
4SD 75/35EC	3	1742	1165	30,6	
4SD 75/45EC	4	2109	1444	39,3	
4SD 8/5EC	0,55	G 2	772	462	11,7
4SD 8/7EC	0,75		898	568	13,6
4SD 8/9EC	1,1		1034	674	15,7
4SD 8/13EC	1,5		1276	886	18,8
4SD 8/19EC	2,2		1694	1204	25
4SD 8/24EC	3	2099	1524	31,8	
4SD 8/32EC	4	2613	1948	41,6	
4SD 10/4EC	0,75	G 2	739	409	12,3
4SD 10/6EC	1,1		875	515	14,2
4SD 10/8EC	1,5		1011	621	16,5
4SD 10/12EC	2,2		1323	833	21,9
4SD 10/17EC	3		1673	1098	28,1
4SD 10/20EC	4	1977	1312	36,2	
4SD 10/22EC	4	2083	1418	37	
4SD 10/24EC	4	2189	1524	37,8	
4SD 10/27EC	5,5	2428	1683	42,1	
4SD 10/30EC	5,5	2587	1842	43,1	
4SD 15/6EC	1,5	G 2	1067	677	16
4SD 15/9EC	2,2		1400	910	28,6
4SD 15/12EC	3		1719	1144	33,6
4SD 15/15EC	4		2111	1446	40
4SD 15/17EC	4		2266	1601	40,8
4SD 15/23EC	5,5	2881	2136	48,6	
4SD 15/30E	7,5 ¹⁾	3455	2681	61,2	

1~	P ₂ kW	DN ISO 228	L mm	L ₁ mm	kg
4SDM 31/11EC	0,37	G 1 1/4	712	402	11,2
4SDM 31/17EC	0,37		830	520	12,2
4SDM 31/26EC	0,55		1028	698	14,5
4SDM 31/35EC	0,75		1235	875	17
4SDM 31/54EC	1,1		1685	1295	21,7
4SDM 41/10EC	0,37	G 1 1/4	693	383	11
4SDM 41/15EC	0,55		811	481	12,7
4SDM 41/20EC	0,75		940	580	14,6
4SDM 41/30EC	1,1		1167	777	17,6
4SDM 41/44EC	1,5		1502	1052	22,6
4SDM 41/60EC	2,2	1868	1368	27,5	
4SDM 45/5EC	0,37	G 1 1/4	638	328	10,6
4SDM 45/7EC	0,55		713	383	12,1
4SDM 45/10EC	0,75		827	467	13,8
4SDM 45/15EC	1,1		997	607	16,5
4SDM 45/21EC	1,5		1224	774	20,5
4SDM 45/30EC	2,2	1525	1025	25,3	
4SDM 5/5EC	0,37	G 1 1/4	638	328	10,6
4SDM 5/7EC	0,55		713	383	12
4SDM 5/10EC	0,75		827	467	13,7
4SDM 5/15EC	1,1		997	607	16,4
4SDM 5/20EC	1,5		1196	746	20,1
4SDM 5/30EC	2,2	1525	1025	25,2	
4SDM 75/4EC	0,37	G 1 1/4	610	300	10,4
4SDM 75/6EC	0,55		686	356	11,8
4SDM 75/9EC	0,75		799	439	13,6
4SDM 75/13EC	1,1		941	551	15,8
4SDM 75/17EC	1,5		1112	662	19,4
4SDM 75/26EC	2,2	1414	914	23,5	
4SDM 8/5EC	0,55	G 2	792	462	12,2
4SDM 8/7EC	0,75		928	568	14,1
4SDM 8/9EC	1,1		1064	674	16,6
4SDM 8/13EC	1,5		1336	886	20,9
4SDM 8/19EC	2,2		1704	1204	25,6
4SDM 10/4EC	0,75	G 2	769	409	12,8
4SDM 10/6EC	1,1		905	515	15,1
4SDM 10/8EC	1,5		1071	621	18,6
4SDM 10/12EC	2,2		1333	833	22,5
4SDM 15/6EC	1,5		G 2	1127	677
4SDM 15/9EC	2,2	1410		910	29,2

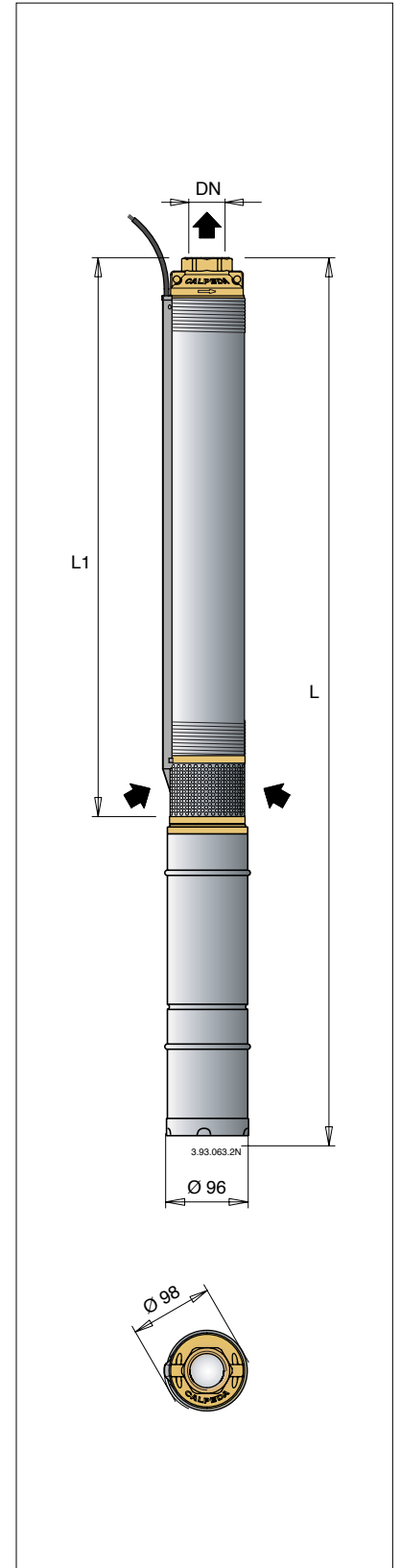

¹⁾ Franklin motor

6SDN 12

Submersible motor pumps for deep wells of 6"

Characteristic curves, performance $n \approx 2900$ rpm, dimensions and weights

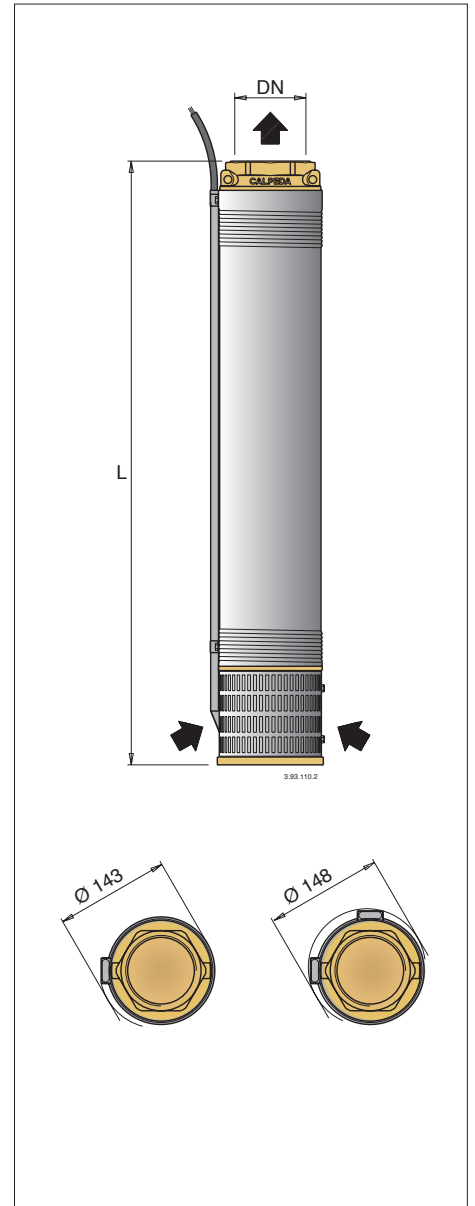
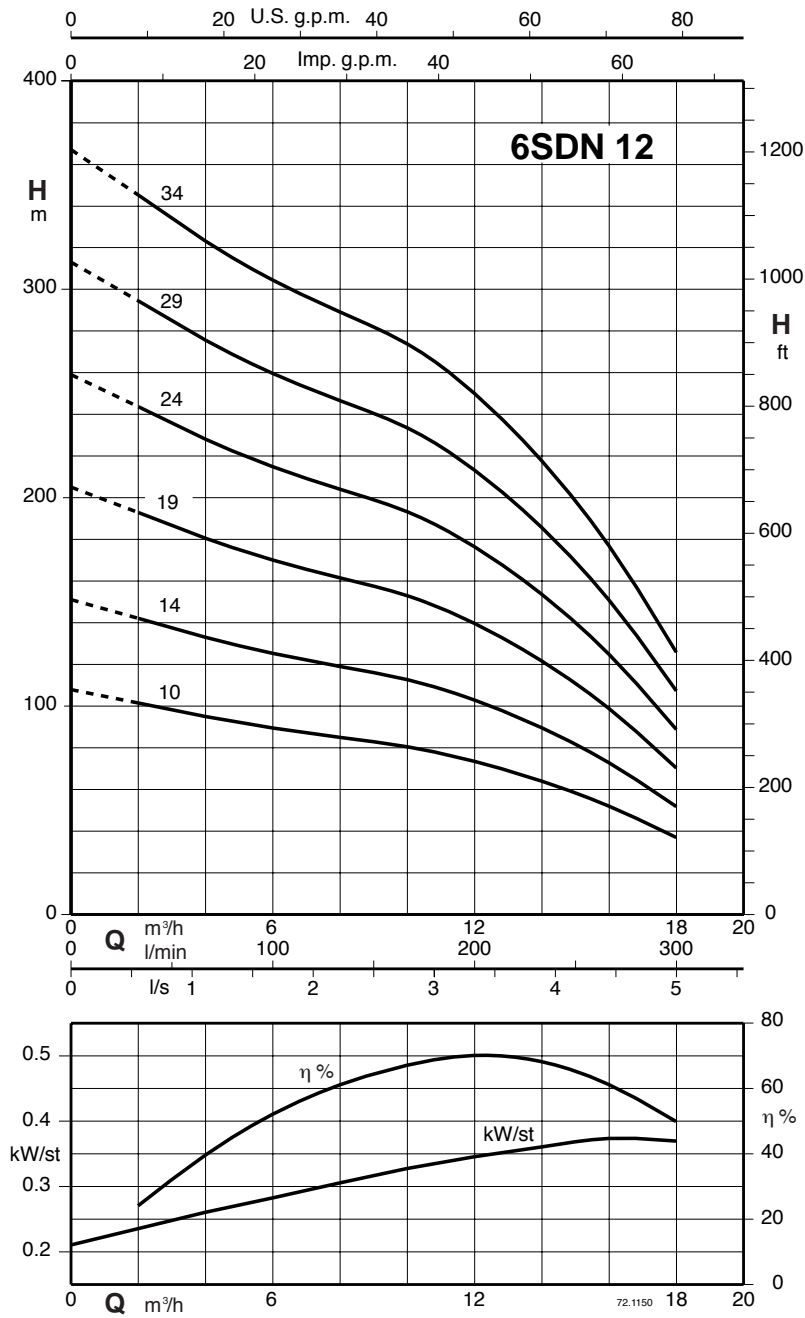

3~	P ₂		Q	n ≈ 2900 rpm											
	kW	HP		m³/h											
				2	4	6	8	10	12	14	16	18			
6SDN 12/10	4	5,5	l/min	33,3	66,6	100	133,3	166,6	200	233	266	300			
6SDN 12/14	5,5	7,5	H m	102	95	89,5	85	80,5	73,5	64	52	37			
6SDN 12/19	7,5	10		142	133	125	119	113	103	89,5	73	52			
6SDN 12/24	9,2	12,5		193	181	170	162	153	140	122	99	70,5			
6SDN 12/29	11	15		244	231	215	204	193	176	154	125	89			
6SDN 12/34	13 (15)	17,5 (20)		294	276	260	247	233	213	186	151	107			
				345	323	304	289	274	250	218	177	126			

DN	L	
	mm	kg
G 3 ISO 228	715	15,5
	870	17,5
	1060	20
	1320	23
	1510	25,7
	1705	28,5

P₂ Rated motor power output

(...) FK motor rated power output

H Total head in m

Tolerances according to ISO 9906, annex A

6SDN 16

Submersible motor pumps for deep wells of 6"

Characteristic curves, performance $n \approx 2900$ rpm, dimensions and weights

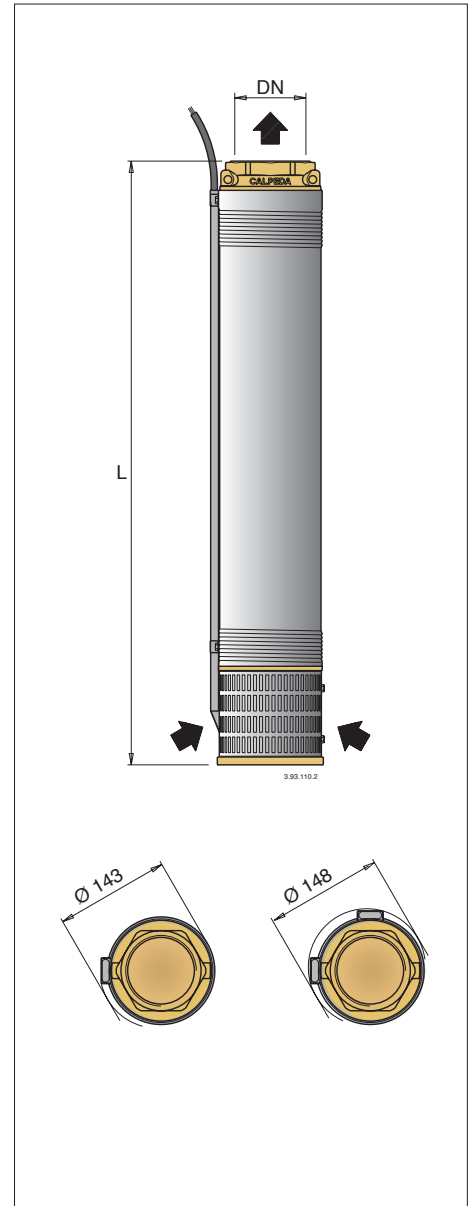
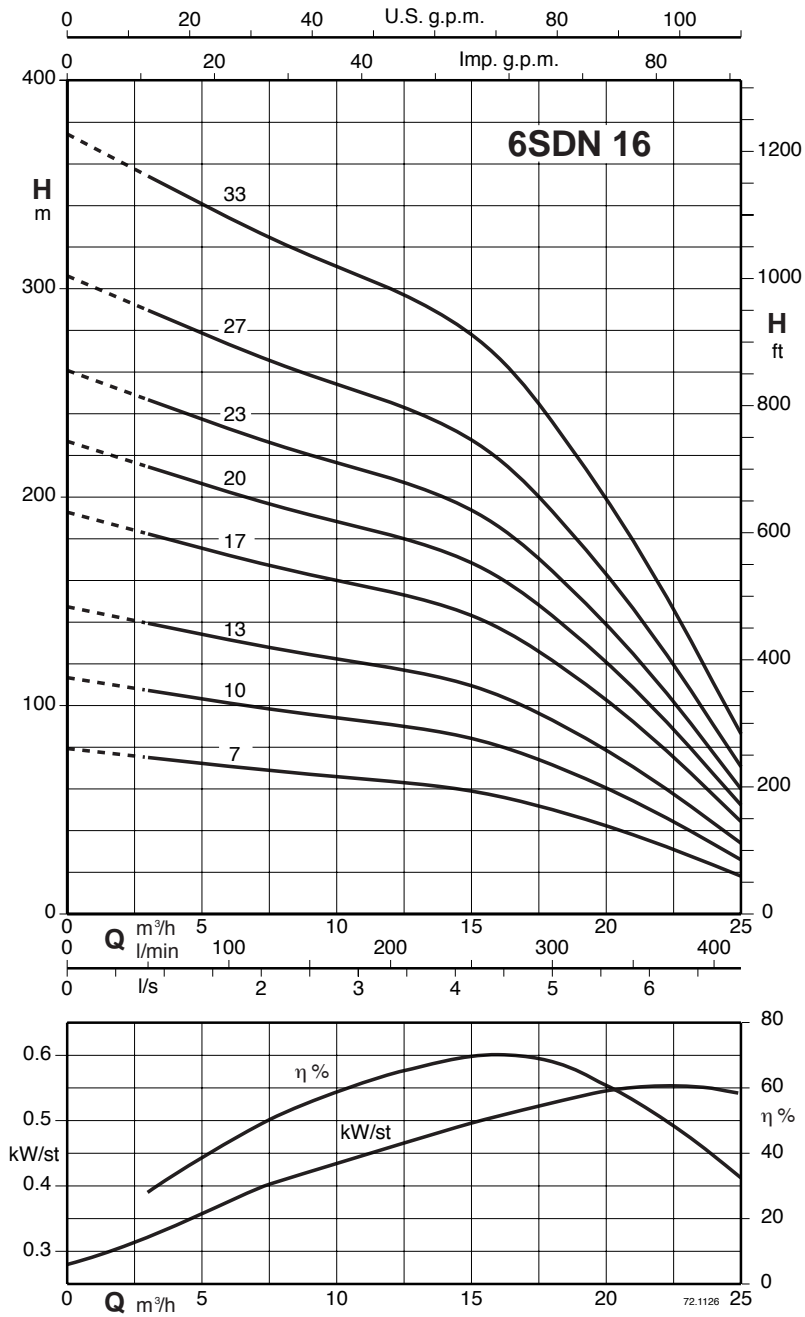

3~	P ₂		Q	n ≈ 2900 rpm											
				3	6	9	12	15	18	21	25				
	kW	HP	m ³ /h	50	100	150	200	250	300	350	416,6				
6SDN 16/7	4	5,5	H	75	71	67	63,5	59	50	38	18,5				
6SDN 16/10	5,5	7,5		107	101	96	91	84	71,5	54,5	26				
6SDN 16/13	7,5	10		139	132	124	118	110	93	70,5	34				
6SDN 16/17	9,2	12,5		182	172	163	155	143	122	92,5	44,5				
6SDN 16/20	11	15		215	202	192	182	168	143	109	52,5				
6SDN 16/23	13 (15)	17,5 (20)		247	233	220	209	194	165	125	60				
6SDN 16/27	15	20		290	273	259	245	227	193	147	71				
6SDN 16/33	18,5	25		354	334	316	300	278	236	179	86,5				

DN	L	
	mm	kg
G 3 ISO 228	600	14
	715	15,5
	830	17
	985	19
	1100	20,5
	1285	22,5
	1435	24,6
	1665	28

P₂ Rated motor power output

(...) FK motor rated power output

H Total head in m

Tolerances according to ISO 9906, annex A

6SDN 21

Submersible motor pumps for deep wells of 6"

Characteristic curves, performance $n \approx 2900$ rpm, dimensions and weights

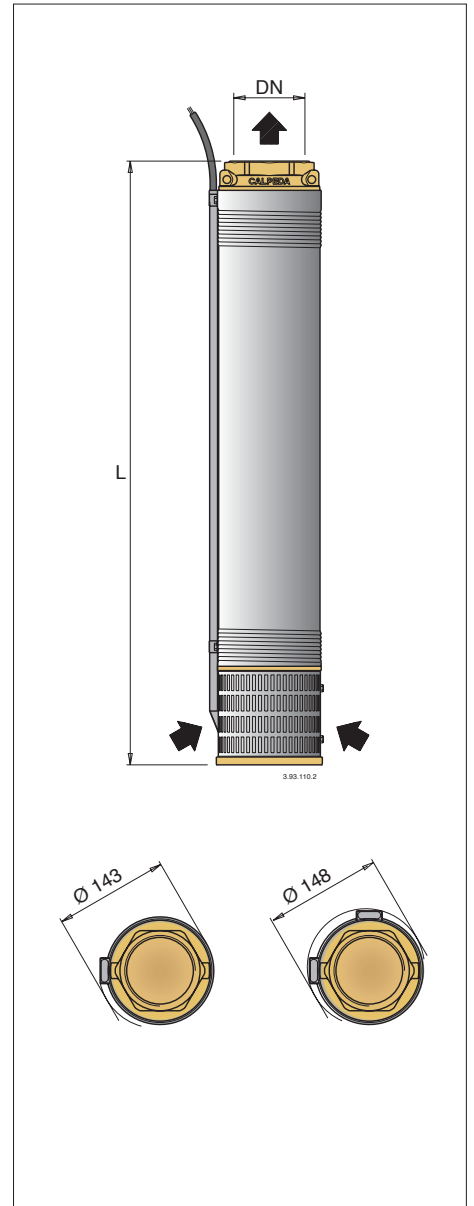
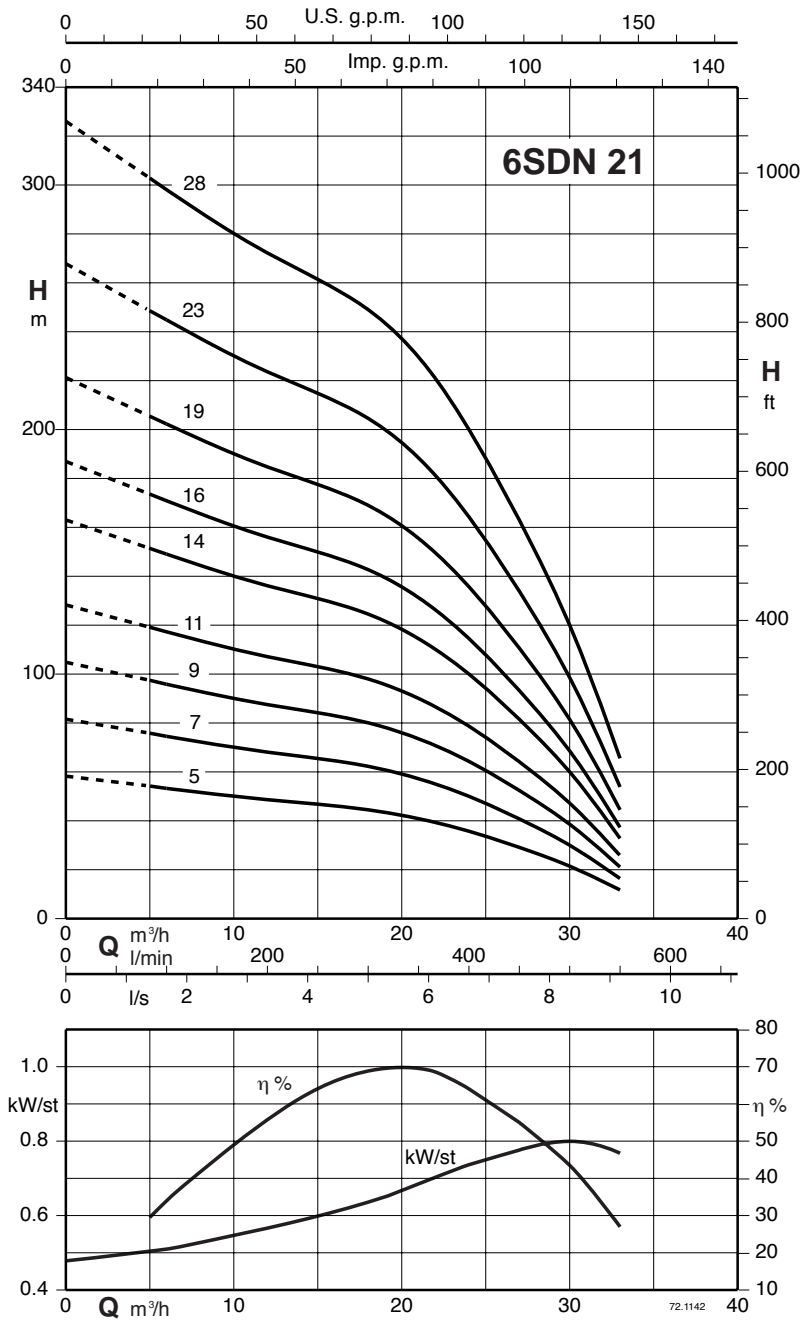

3~	P ₂		Q	n ≈ 2900 rpm											
				m³/h											
	kW	HP		l/min	5	9	12	15	18	21	24	27	30	33	
6SDN 21/5	4	5,5	H m	83,3	150	200	250	300	350	400	450	500	550		
6SDN 21/7	5,5	7,5		54	51	48,5	46,5	45	41,5	36	29	21,5	11,5		
6SDN 21/9	7,5	10		75,5	71,5	68	65	62,5	58	50	41	30	16		
6SDN 21/11	9,2	12,5		97	92	87,5	83,5	80,5	74,5	64,5	53	38,5	21		
6SDN 21/14	11	15		119	112	107	102	99	91	79	64	47	25,5		
6SDN 21/16	13 (15)	17,5 (20)		151	143	136	130	125	116	100	81,5	60	32,5		
6SDN 21/19	15	20		173	163	155	149	143	132	114	93	69	37		
6SDN 21/23	18,5	25		205	194	185	176	170	157	136	111	81,5	44		
6SDN 21/28	22	30		249	235	224	213	206	190	164	134	99	53		
				303	286	272	260	251	231	200	163	120	64,5		

DN	L	
	mm	kg
G 3 ISO 228	565	13,3
	660	14,5
	755	15,7
	850	16,9
	990	18,7
	1085	19,9
	1225	21,7
1480	24,5	
1710	27,5	

6SD 18

Submersible motor pumps for deep wells of 6"

Characteristic curves, performance $n \approx 2900$ rpm, dimensions and weights

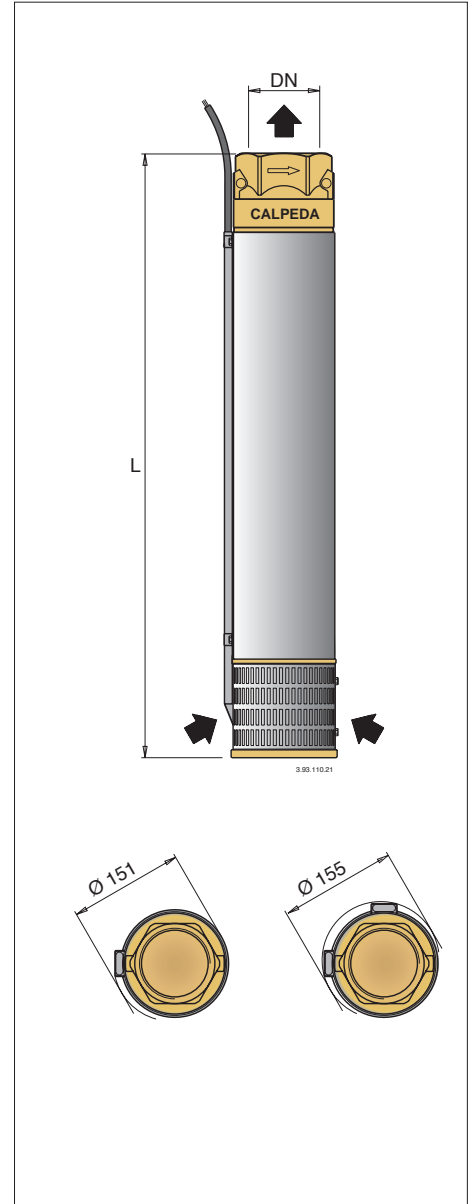
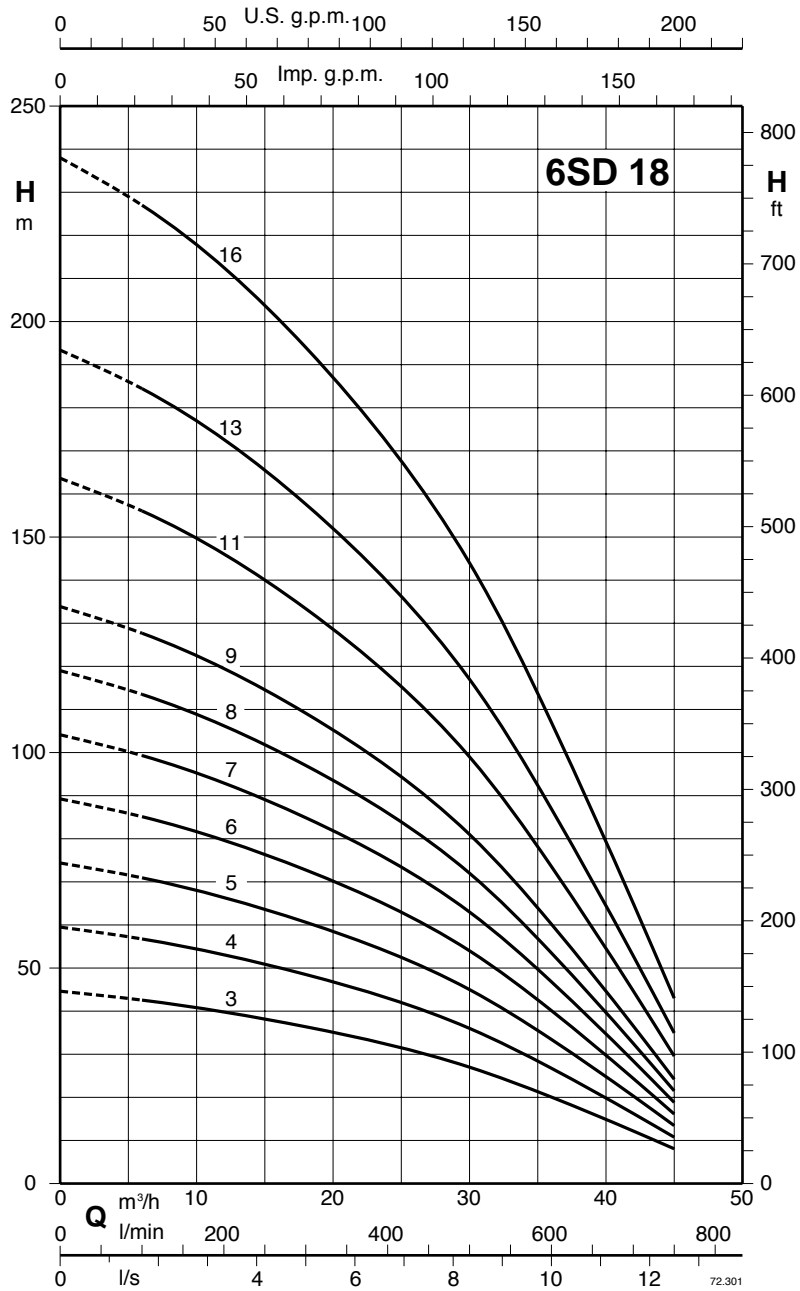

3 ~	P ₂		Q	n ≈ 2900 rpm											
				H											
	kW	HP		m³/h	6	12	18	24	30	36	42	45			
6SD 18/3	4	5,5	42	39	36	32	27	20	12	8					
6SD 18/4	5,5	7,5	56	53	48	43	36	27	16	11					
6SD 18/5	7,5	10	70	66	60	53	45	34	21	13					
6SD 18/6	9,2	12,5	85	79	72	64	54	40	25	16					
6SD 18/7	9,2	12,5	100	93	84	75	63	46	28	19					
6SD 18/8	11	15	113	105	96	86	72	54	32	21					
6SD 18/9	13 (15)	17,5 (20)	127	119	108	96	81	60	37	24					
6SD 18/11	15	20	156	145	132	118	99	74	45	30					
6SD 18/13	18,5	25	184	172	157	139	117	87	52	35					
6SD 18/16	22	30	227	213	194	172	144	107	65	43					

DN	L	
	mm	kg
G 3 ISO 228	647	20,5
	756	23
	865	25
	974	27
	1083	29,5
	1192	32
	1301	34,5
	1519	39,5
	1737	43
	2064	50,2

P₂ Rated motor power output

(...) FK motor rated power output

H Total head in m

Tolerances according to ISO 9906, annex A

6SD 19

Submersible motor pumps for deep wells of 6"

Characteristic curves, performance $n \approx 2900$ rpm, dimensions and weights

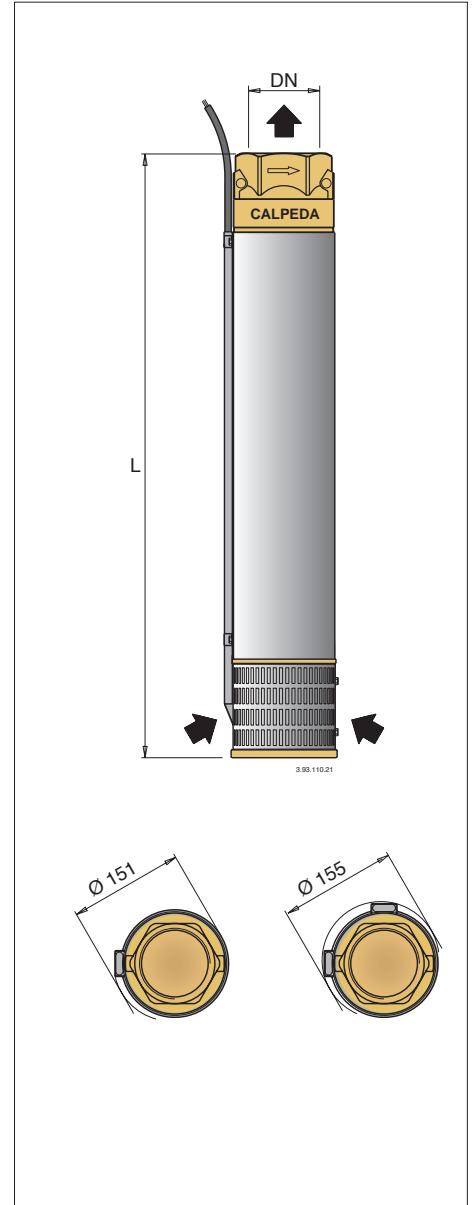
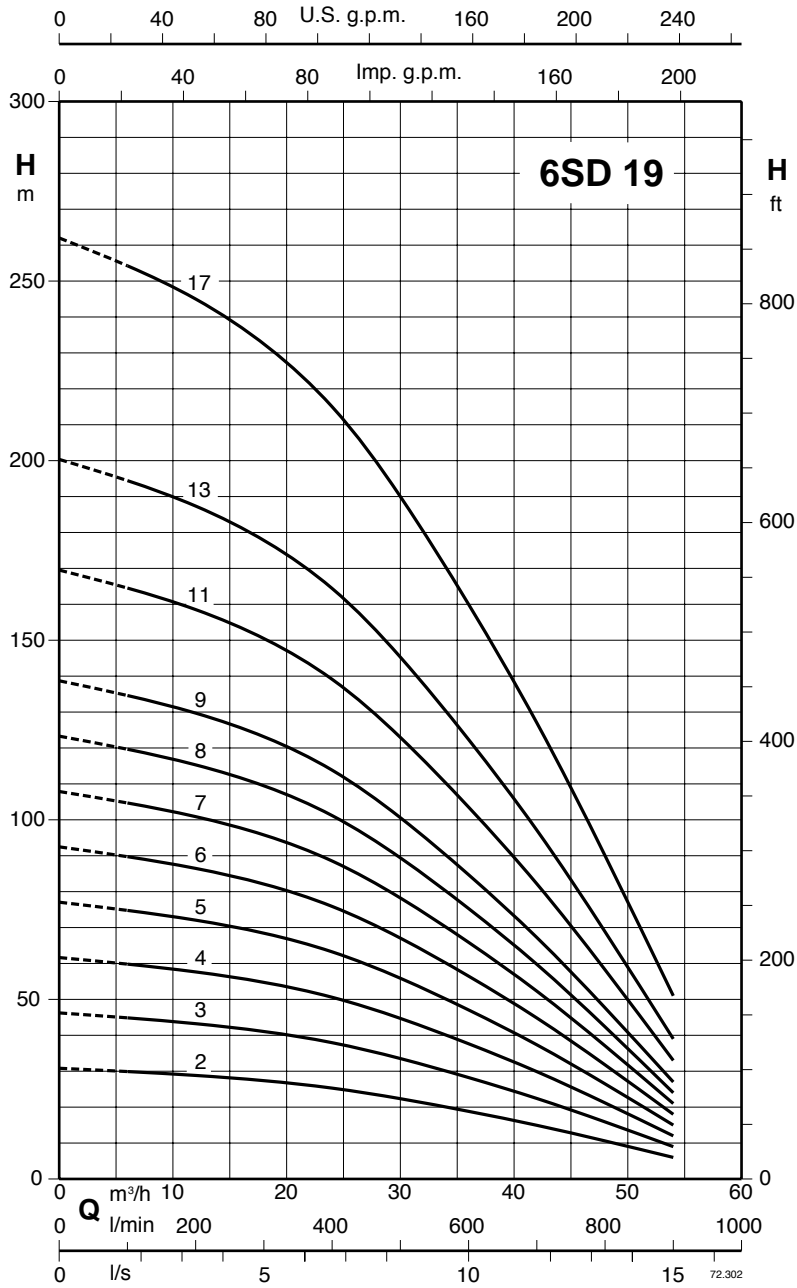

3~	P ₂		Q	n ≈ 2900 rpm										
				m³/h										
	kW	HP	l/min	6	12	18	24	30	36	42	48	54		
6SD 19/2				4	5,5	30	29	27	25	22	19	15	10	6
6SD 19/3	5,5	7,5	45	43	41	38	33	29	23	15	9			
6SD 19/4	7,5	10	60	57	55	50	45	38	30	21	12			
6SD 19/5	9,2	12,5	75	72	69	63	56	47	38	26	15			
6SD 19/6	11	15	90	86	82	75	67	56	45	31	18			
6SD 19/7	13 (15)	17,5 (20)	105	100	96	88	79	66	53	37	21			
6SD 19/8	15	20	120	115	110	101	89	75	60	42	24			
6SD 19/9	15	20	135	130	123	114	100	85	68	47	27			
6SD 19/11	18,5	25	165	158	151	139	123	104	83	58	33			
6SD 19/13	22	30	195	188	179	164	145	122	98	69	39			
6SD 19/17	30	40	255	245	234	215	190	160	127	90	51			

DN	L	
	mm	kg
G 3 ISO 228	538	18
	647	20,5
	756	23
	865	25
	974	27
	1083	29,5
	1192	32
	1301	34,5
	1519	39,5
	1737	43
2173	53	

P₂ Rated motor power output

(...) FK motor rated power output

H Total head in m

Tolerances according to ISO 9906, annex A

6SD 20

Submersible motor pumps for deep wells of 6"

Characteristic curves, performance $n \approx 2900$ rpm, dimensions and weights

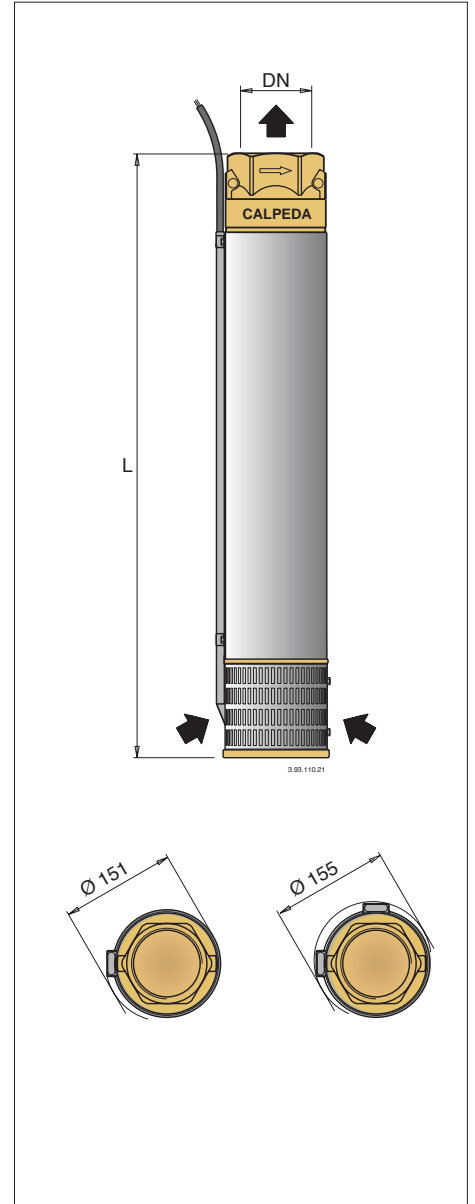
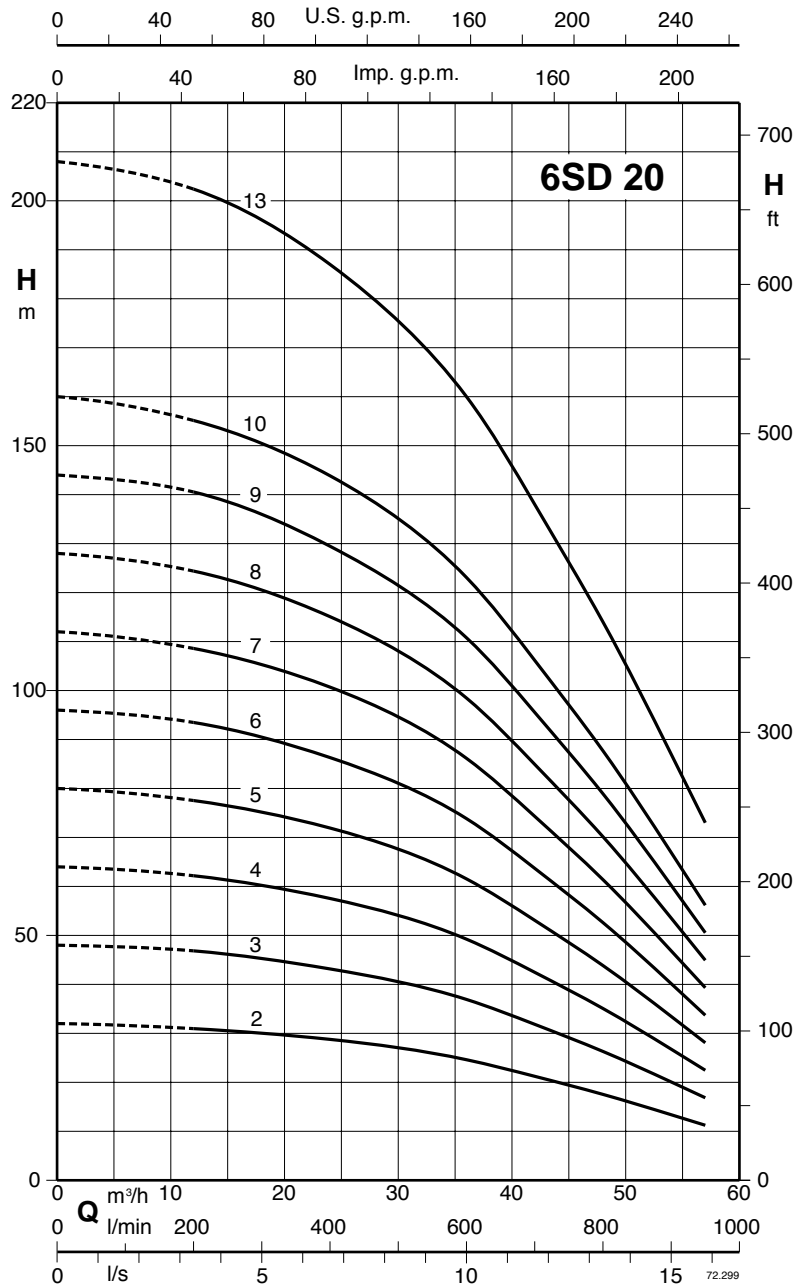

3~	P ₂		Q	n ≈ 2900 rpm														
	kW	HP		H														
				m														
			m ³ /h	12	18	24	30	36	42	48	54	57						
			l/min	200	300	400	500	600	700	800	900	950						
6SD 20/2	5,5	7,5		31	30	29	28	24	21	17	13	11						
6SD 20/3	7,5	10		46	45	44	42	37	32	26	20	17						
6SD 20/4	9,2	12,5		62	60	58	55	49	42	35	26	22						
6SD 20/5	11	15		77	76	73	68	61	53	44	33	28						
6SD 20/6	13 (15)	17,5 (20)		93	91	87	83	73	63	53	40	34						
6SD 20/7	15	20		108	106	102	96	86	74	61	47	39						
6SD 20/8	18,5	25		124	120	115	110	99	85	70	53	45						
6SD 20/9	18,5	25		140	136	130	124	111	96	79	60	51						
6SD 20/10	22	30		155	151	144	138	123	106	88	67	56						
6SD 20/13	30	40		202	196	188	179	160	138	114	87	73						

DN	L1	
	mm	kg
G 3 ISO 228	538	18
	647	20,5
	756	23
	865	25
	974	27
	1083	29,5
	1192	32
	1301	34,5
1410	36,2	
1737	44,4	